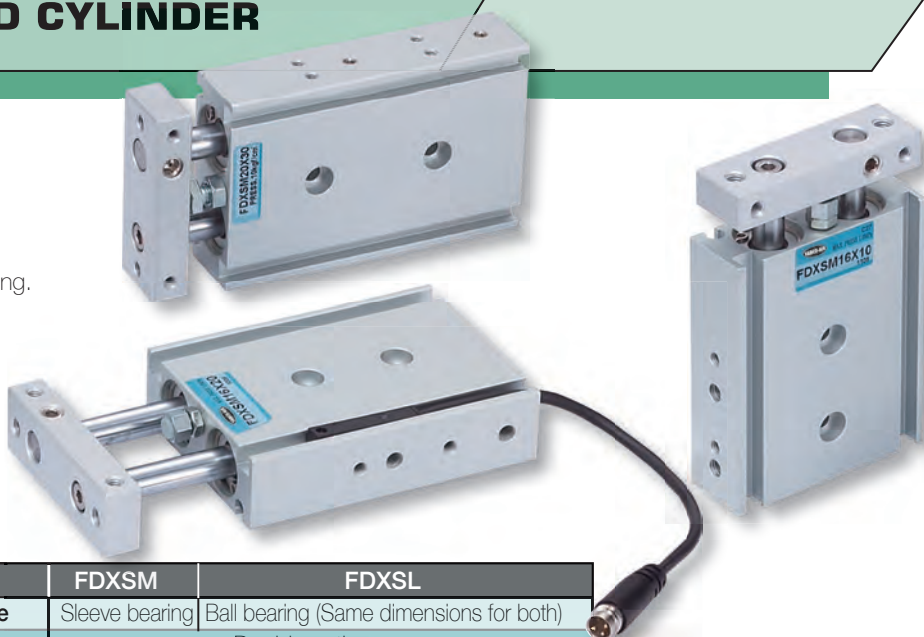

FABCO-AIR**FDXS Series
TWIN-ROD CYLINDER****Features**

1. Magnetic piston is standard in all sizes.
2. Non-rotating design enables precision positioning.
3. Compact design saves space.
4. Suitable for multi-axis assemblies and design of robot arms.
5. Twin bore doubles thrust forces.
6. Easily adjustable sensors mount in linear slots in the housing.
7. Cylinders can be operated with or without lubrication.

**Specifications**

100 psi max.

Model	FDXSM	FDXSL
Bearing type	Sleeve bearing	Ball bearing (Same dimensions for both)
Action	Double acting	
Bore Size	ø10, ø16, ø20, ø25, ø32	
Media	Compressed air	
Min. operating pressure	ø10 ~ ø16: 0.1 MPa (1.0 kgf/cm ²) 15 psi ø20 ~ ø32: 0.05 MPa (0.51 kgf/cm ²) 8 psi	
Max. operating pressure 100psi	0.7 MPa (7 kgf/cm ²) 100 psi	
Piston speed	ø10 ~ ø20: 30 ~ 700mm/s (27.6 in/s) ø25 ~ ø32: 30 ~ 600mm/s (23.6 in/s)	
Ambient & media temperature	-10°C(14°F) ~ +60°C(140°F) filtered dry air required at temperatures below 0°C (32°F)	
Lubrication	None required, or ISO VG32	
Port size	• ø10 ~ ø20: M5x0.8 • ø25~ ø32: Rc(PT) 1/8"	
Adjustable retract stroke	0 ~ 5mm	
Cushion	Standard with rubber bumper (both sides)	

Conversions

psi = kgf/cm² x 14.2
 psi = MPa x 145
 inch = mm x 0.0394
 lb force = N x 0.22

Theoretical Output N (lbf)* Theoretical output: (N)=Pressure (MPa) X Piston area (mm²)

Bore size (mm)	Rod size (mm)	Operating direction	Piston area mm ² (in ²)	Operating pressure MPa (psi)						
				0.1(14.5)	0.2(29)	0.3(43)	0.4(58)	0.5(72)	0.6(87)	0.7(101)
FDXS □ 10	6	Push	157(0.24)	15.7(3.5)	31.4(7)	47.1(10)	62.8(14)	78.5(17)	94.2(21)	110(24)
		Pull	100(0.15)	10.0(2.2)	20.0(4.3)	30.0(6.4)	40.0(8.7)	50.0(10)	60.0(13)	70.0(15)
FDXS □ 16	8	Push	402(0.62)	40.2(9.0)	80.4(18)	120.6(26)	161(36)	201(44)	241(54)	281(62)
		Pull	301(0.46)	30.1(6.7)	60.2(13)	90.3(19)	120(26)	150(33)	181(40)	211(46)
FDXS □ 20	10	Push	628(0.97)	62.8(14)	126(28)	188(41)	251(56)	314(70)	377(84)	440(98)
		Pull	471(0.73)	47.1(10.6)	94.2(21)	141(31)	188(42)	236(52)	283(63)	330(73)
FDXS □ 25	12	Push	982(1.52)	98.2(22)	196(44)	295(65)	393(88)	491(109)	589(132)	687(153)
		Pull	756(1.17)	75.6(17)	151(34)	227(50)	302(68)	378(84)	454(101)	529(118)
FDXS □ 32	16	Push	1608(2.49)	161(36)	322(72)	482(107)	643(144)	804(179)	965(216)	1126(251)
		Pull	1206(1.87)	120(27)	241(54)	362(80)	482(108)	603(134)	724(162)	844(189)

h

Fabco-Air, Inc. ■ 3716 N.E. 49th Avenue ■ Gainesville, FL 32609-1699
 ■ Telephone (352) 373-3578 ■ Fax (352) 375-8024 ■ E-Mail service@fabco-air.com
 ■ Web Site <http://www.fabco-air.com>

TWIN-ROD CYLINDER

Construction

FDXSM / FDXSL 10

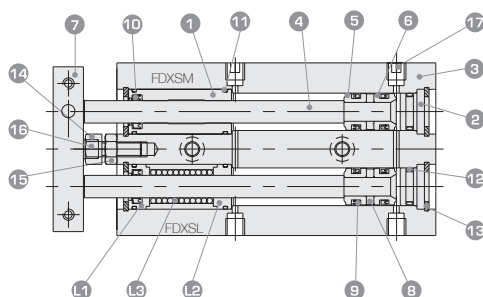

FDXSM / FDXSL 16 - 25

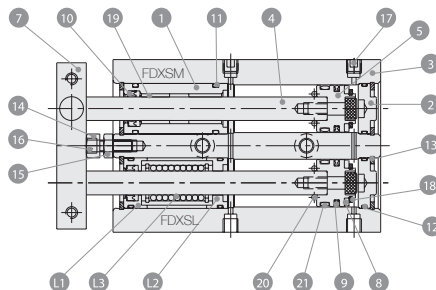

FDXSM / FDXSL 32

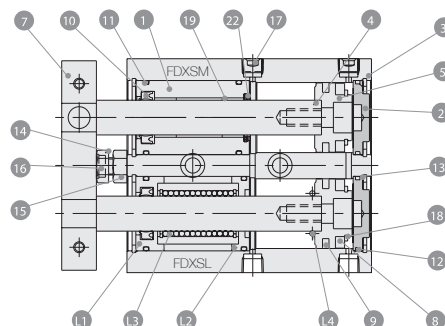

Part lists

No.	Description	Material	Q'ty
1	Rod cover	Aluminum alloy	2
2	Head cover	Aluminum alloy	2
3	Housing	Aluminum alloy	1
4	Piston rod	303 Stainless steel	2
5	Piston	Aluminum alloy	2
6	Piston	Aluminum alloy	2
7	Tool plate	Aluminum alloy	1
8	Magnet	Rubber bonded barium ferrite	2
9	Piston seal	Nitrile - Buna N	2
10	Rod seal	Nitrile - Buna N	2
11	O-ring	Nitrile - Buna N	4
12	O-ring	Nitrile - Buna N	2
13	Snap ring	Plated steel	4

No.	Description	Material	Q'ty
14	Bumper bolt	Plated carbon steel	1
15	Hexagon nut	Plated carbon steel	1
16	Bumper	Polyurethane	1
17	Plug	Plated carbon steel	2
18	Bumper	Acetal	2
19	Bush	—	4
20	O-ring	Nitrile - Buna N	2
21	Bumper	Acetal	2
22	Bumper	Polyurethane	2
L1	Bearing retainer	Aluminum alloy	2
L2	Bearing retainer	Aluminum alloy	2
L3	Ball bearing	—	2
L4	O-ring	Nitrile - Buna N	2

Weights

kg (lb)

Model	Standard stroke (mm)							
	10	20	30	40	50	60	75	100
FDXSM10	0.15(0.33)	0.17(0.37)	0.19(0.41)	0.21(0.46)	0.23(0.50)	0.25(0.55)	0.28(0.61)	0.33(0.72)
FDXSL10	0.15(0.33)	0.17(0.37)	0.19(0.41)	0.21(0.46)	0.23(0.50)	0.25(0.55)	0.28(0.61)	0.33(0.72)
FDXSM16	0.25(0.55)	0.28(0.61)	0.30(0.66)	0.33(0.72)	0.36(0.79)	0.39(0.86)	0.435(0.96)	0.51(1.12)
FDXSL16	0.27(0.59)	0.30(0.66)	0.32(0.70)	0.35(0.77)	0.38(0.83)	0.41(0.90)	0.435(0.96)	0.53(1.17)
FDXSM20	0.40(0.88)	0.44(0.97)	0.48(1.05)	0.51(1.12)	0.55(1.21)	0.585(1.29)	0.65(1.43)	0.74(1.63)
FDXSL20	0.43(0.95)	0.46(1.01)	0.50(1.10)	0.53(1.17)	0.57(1.25)	0.605(1.33)	0.66(1.45)	0.75(1.65)
FDXSM25	0.61(1.34)	0.66(1.45)	0.72(1.58)	0.77(1.69)	0.83(1.83)	0.89(1.96)	0.97(2.14)	1.10(2.42)
FDXSL25	0.62(1.36)	0.67(1.47)	0.73(1.60)	0.78(1.71)	0.84(1.85)	0.895(1.97)	0.98(2.16)	1.11(2.44)
FDXSM32	1.15(2.53)	1.23(2.71)	1.32(2.91)	1.40(3.08)	1.49(3.28)	1.58(3.48)	1.71(3.77)	1.93(4.25)
FDXSL32	1.16(2.55)	1.25(2.75)	1.34(2.95)	1.42(3.13)	1.51(3.33)	1.595(3.51)	1.72(3.79)	1.94(4.27)

How to order

FDXS

L

20

X

50

Model

Bearing type

Bore size

Stroke

Sleeve bearing
M

Ball bearing
L

ø 10

ø 16

ø 20

ø 25

ø 32

Please select strokes from the attached table

Model	Standard Strokes (mm)							Long stroke (mm)				
	10	20	30	40	50	60	75	100	125	150	175	200
FDXS□10	●	●	●	●	●	●	●	●				
FDXS□16	●	●	●	●	●	●	●	●	※	※		
FDXS□20	●	●	●	●	●	●	●	●	※	※	※	※
FDXS□25	●	●	●	●	●	●	●	●	※	※	※	※
FDXS□32	●	●	●	●	●	●	●	●	※	※	※	※

「●」 Standard Stroke 「※」 For long or custom strokes, consult factory.

Position Sensors

See specifications in the sensor selection guides below. Please order sensors and female cordsets separately from the charts below.

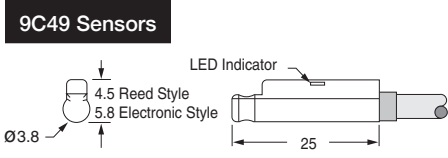
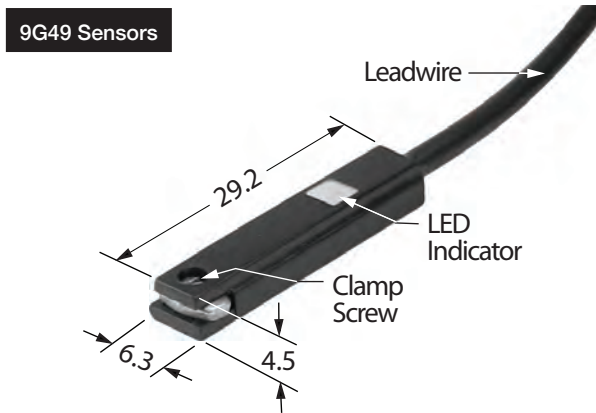

All 9G49 sensors feature surge protection, polarity protection, LED indicator, and extremely fast switching speeds

Female Cord Sets	Part No.	Price
1 Meter	CFC-1M	-
2 Meters	CFC-2M	-
5 Meters	CFC-5M	-

9G49 Sensor Selection Guide for all bore sizes ø10 ~ ø32			Prewired 9 ft. Leadwire		Quick Disconnect*	
6.3 mm wide	Sensor Type	Electrical Characteristics	Part No.	Price	Part No.	Price
	Reed (LED)	5-120 VDC/VAC, 0.03 Amp max, 0.005 AMP min, 4 Watt max., 2.0 voltage drop	9G49-000-002-	9G49-000-302-
	Electronic (LED)	Sourcing PNP 5-28 VDC, 0.20 Amp max current, 0.5 voltage drop	9G49-000-031-	9G49-000-331-
	Electronic (LED)	Sinking NPN 5-28 VDC, 0.20 Amp max current, 0.5 voltage drop	9G49-000-032-	9G49-000-332-

9G49 Sensor Selection Guide for bore sizes ø20 ~ ø32			Prewired 9 ft. Leadwire		Quick Disconnect*	
4 mm round	Sensor Type	Electrical Characteristics	Part No.	Price	Part No.	Price
	Reed (LED)	5-120 VDC/VAC, 0.04 Amp max, 0.005 Amp min current, 4 Watt max., 2.5 voltage drop	9G49-000-002-	9G49-000-302-
	Electronic (LED)	Sourcing PNP 6-30 VDC, 0.2 Amp max current, 6 Watt max., 1.5 voltage drop	9G49-000-031-	9G49-000-331-
	Electronic (LED)	Sinking NPN 6-30 VDC, 0.2 Amp max current, 6 Watt max., 1.5 voltage drop	9G49-000-032-	9G49-000-332-

*Note: All quick disconnect style sensors are supplied with 6 inch pigtail with male connector.

Model Selection

⚠ Caution Theoretical output must be confirmed separately, referring to the tables and graphs below.

● Vertical mounting

Mounting orientation					
Max. speed - mm/sec (in/sec)		200 (7.9 in/s)	400 (15.8 in/s)	600 (23.6 in/s)	700 (27.6 in/s) 800 (31.6 in/s)
Stroke(mm)		All strokes			
Selection graph	ø10	(A)	(B)	(C)	(D)
	ø16				
	ø20				
	ø25				
	ø32				
600 mm/s max. for ø25 & ø32					

● Vertical mounting ø10~ø32

(A) V = 200 mm/sec (7.9 in/sec)

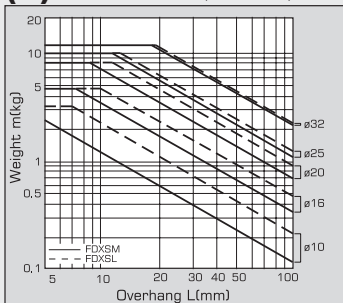

(B) V = 400 mm/sec (15.8 in/sec)

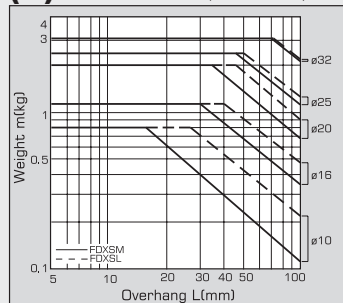

(C) V = 600 mm/sec (23.6 in/sec)

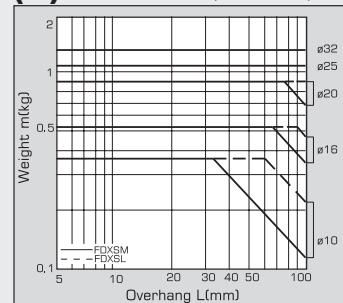

(D) V = 700 mm/sec (27.6 in/sec)

[ø10: V = 800 mm/sec (31.6 in/sec)]

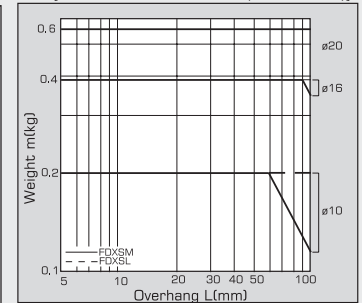

● Horizontal mounting ø10~ø32 (400 mm/sec = 15.8 in/sec)

(E) V = 400 mm/sec: 10 stroke

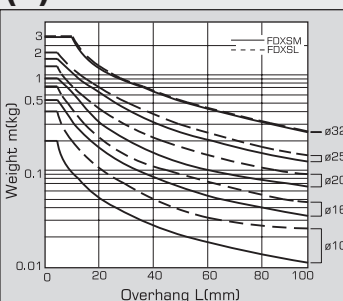

(F) V = over 400 mm/sec: 10 stroke

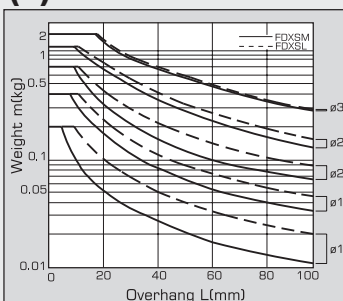

(G) V = 400 mm/sec: 30 stroke max.

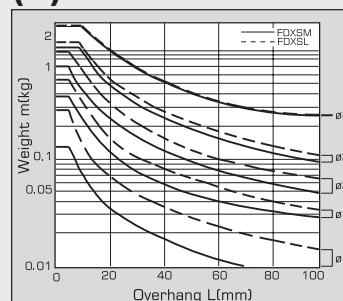

(H) V = over 400 mm/sec: 30 stroke max.

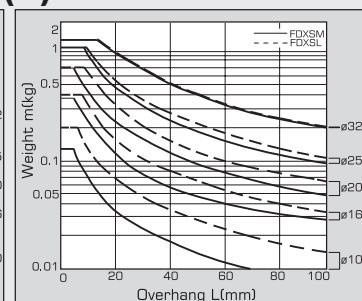

Model Selection

⚠ Caution Theoretical output must be confirmed separately, referring to the tables below.

● Horizontal mounting

Mounting orientation	Case 1				Case 2					
Stroke (mm)	10		Under 30		Under 50		Under 75		Under 100	
Max. speed (mm/s) (400mm/sec. = 15.9 in/sec.)	400	400 Over	400	400 Over	400	400 Over	400	400 Over	400	400 Over
Selection graph	∅10	(E)	(F)	(G)	(H)	(I)	(J)	(K)	(L)	
	∅16									
	∅20									
	∅25									
	∅32									
	See graph page 4	See graph page 4	See graph page 4	See graph page 4	See graph below	See graph below	See graph below	See graph below	See graph below	

* Refer to the caution notes below.

*The maximum speed for ∅10 to ∅32 are : ∅10 : 800 mm/s ; ∅16 · ∅20 : 700 mm/s ; ∅25 · ∅32 : 600 mm/s

⚠ Caution for Case 2

*If the cylinder is horizontally mounted and the tool plate end does not reach the load's center of gravity, use the formula below to calculate the effective length L' that includes the distance between the load's center of gravity and the tool plate midplane. Select the graph that corresponds to the effective length L'.

Effective length L' = (stroke) + K + L.

Bore size	K
∅10	4 mm
∅16	5 mm
∅20	6 mm
∅25	
∅32	8 mm

K = Distance between the mid-plane and end of the tool plate.

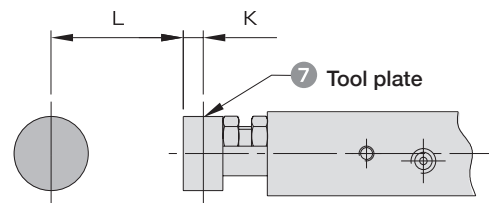

(Example)
When using FDXSM10x10 and L = 15mm: effective length L' = 10 + 4 + 15 = 29. Therefore, the graph used for your model selection should be the one for FDXSM10x30

● Horizontal mounting ∅10~∅32 (400 mm/sec = 15.8 in/sec)

(I) V = 400 mm/sec: 50 stroke max.

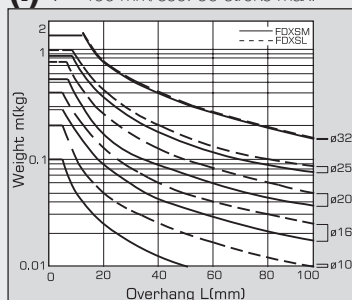

(J) V = over 400 mm/sec: 50 stroke max.

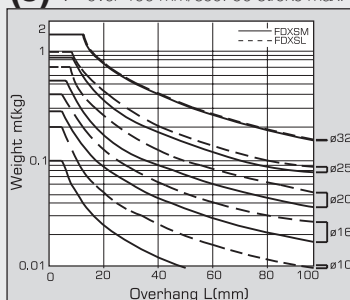

(K) 75 stroke max.

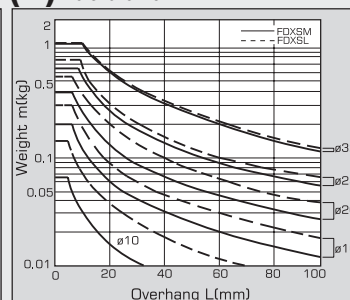

(L) 100 stroke max.

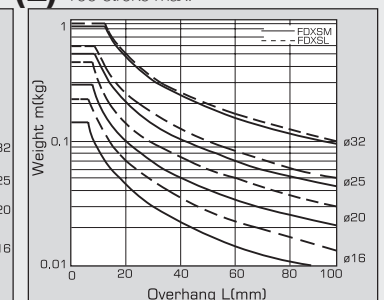

External Dimensions (mm)

FDXS□10~16

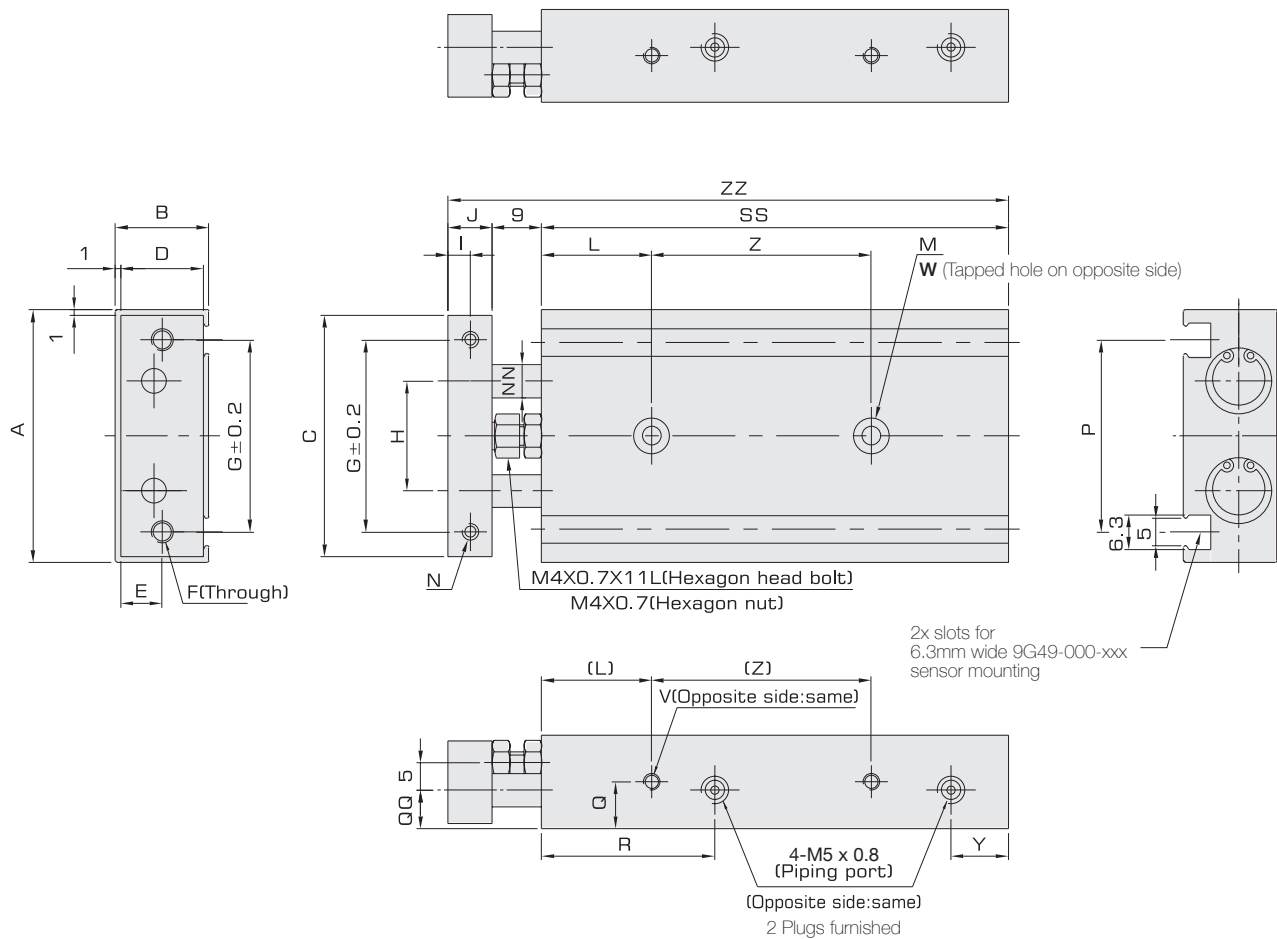

Model	A	B	C	D	E	F	G	H	I	J	L	M	N	NN	P	Q	QQ	R	V	W	Y
FDXS□10	46	17	44	15	7.5	2-M4X0.7	35	20	4	8	20	2- ϕ 3.4 through 2- ϕ 6.5 counterbore with depth 4	2-M3X0.5 dp. 5	ϕ 6	35	8.5	7	31.5	2-M3X0.5 dp. 4.5	2-M4X0.7	10.5
FDXS□16	58	20	56	18	9	2-M5X0.8	45	25	5	10	30	2- ϕ 4.3 through 2- ϕ 8 counterbore with depth 4.4	2-M4X0.7 dp. 6	ϕ 8	48	10	10	39.5	4-M4X0.7 dp. 5	2-M5X0.8	9

Stroke Model	SS								Z				ZZ							
	10	20	30	40	50	60	75	100	10、20	30、40、50	60、75	100	10	20	30	40	50	60	75	100
FDXS□10	65	75	85	95	105	115	130	155	30	40	50	60	82	92	102	112	122	132	147	172
FDXS□16	70	80	90	100	110	120	135	160	25	35	45	55	89	99	109	119	129	139	154	179

External Dimensions (mm)

FDXS□ 20~32

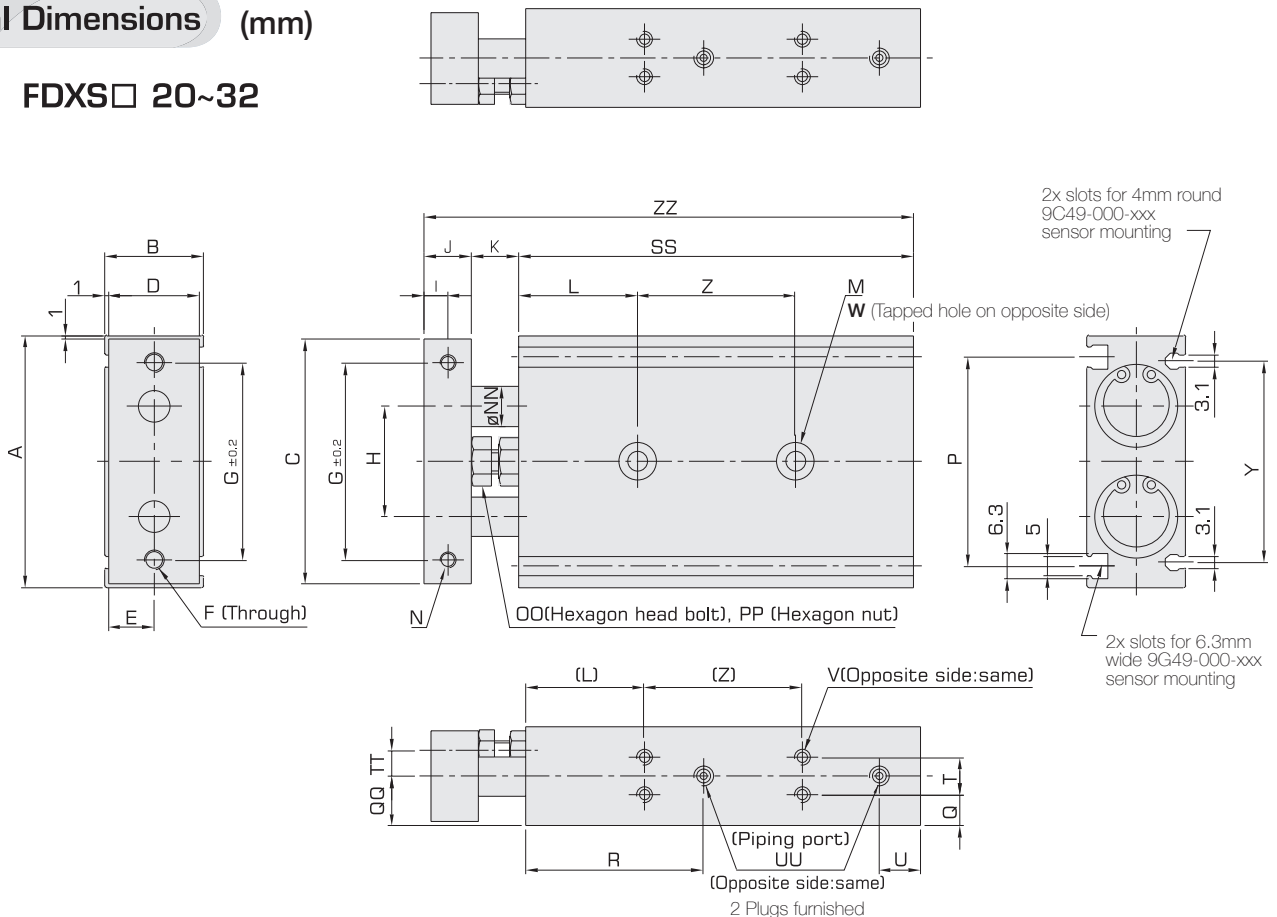

Model	A	B	C	D	E	F	G	H	I	J	K	L	M	N	NN	OO	P
FDXS□20	64	25	62	23	11.5	2-M5X0.8	50	28	6	12	12	30	2- ϕ 5.5 through 2- ϕ 9.5 counterbore , dp. 5.5	2-M4X0.7 dp. 6	ϕ 10	M6X1.0	53
FDXS□25	80	30	78	28	14	2-M6X1.0	60	35	6	12	12	30	2- ϕ 6.9 through 2- ϕ 11 counterbore , dp. 6.3	2-M5X0.8 dp. 7.5	ϕ 12	M6X1.0	64
FDXS□32	98	38	96	36	18	2-M6X1.0	75	44	8	16	14	30	2- ϕ 6.9 through 2- ϕ 11 counterbore , dp. 6.3	2-M5X0.8 dp. 8	ϕ 16	M8X1.25	76

Model	PP	Q	QQ	R	T	TT	U	UU	V	W	Y
FDXS□20	M6X1.0	7.75	12.5	45	9.5	6.5	10.5	4-M5X0.8dp. 4.5	8-M4X0.7dp. 5.5	2-M6X1.0	51
FDXS□25	M6X1.0	8.5	15	48	13	9	10	4-PT1/8"dp. 6.5	8-M5X0.8 dp. 7.5	2-M8X1.25	62
FDXS□32	M8X1.25	9	19	57.5	20	11.5	10.5	4-PT1/8"dp. 6.5	8-M5X0.8dp. 8	2-M8X1.25	74

Stroke	SS									Z			ZZ						
	10	20	30	40	50	60	75	100	10、20	30、40、50	60、75、100	10	20	30	40	50	60	75	100
FDXS□20	80	90	100	110	120	130	145	170	30	40	60	104	114	124	134	144	154	169	194
FDXS□25	82	92	102	112	122	132	147	172	30	40	60	106	116	126	136	146	156	171	196
FDXS□32	92	102	112	122	132	142	157	182	40	50	70	122	132	142	152	162	172	187	212



Cylinders, Valves and Accessories
Catalog # CV9



Pancake® II Air Cylinders
Catalog # Pan2-2



Square Pancake® II Air Cylinders
Catalog # SqPan2



Multi-Power® Air Presses
Catalog # FP16



Linear Slides - 6 Families
Catalog # LS-03

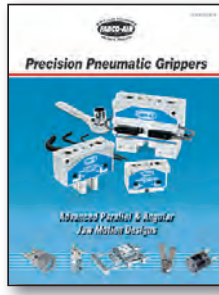

Pneumatic Grippers
Parallel Jaw and Angular Motion - Catalog # GR-8



NFPA Interchangeable Air Cylinders - Catalog # NF-6

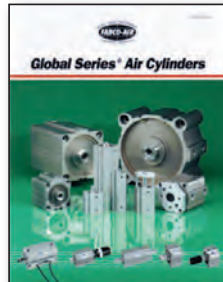

Global Series™ Metric Air Cylinders - Catalog # GC-15



Swing Clamps
Bulletin # SC-DB04



Modular Air Preparation System - FRLs
Catalog # FRL-06



Specialty & Control Valves
Catalog # 14CAN



Stopper Cylinders
Catalog # ST-SC

Check out these new product lines today !



ISO 6431 Cylinders
Catalog # FAQR-09



Pneumatic Angular Motion Grippers
Catalog # FKA-09



ISO 6432 Cylinders
Catalog # FAE-09



Rotary Actuators, Pneumatic
Catalog # FRA-C-09

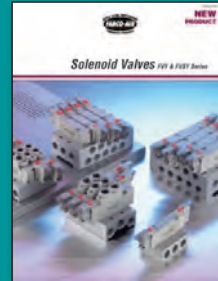

Manifold Solenoid Valves
Catalog # FVS-Y-09

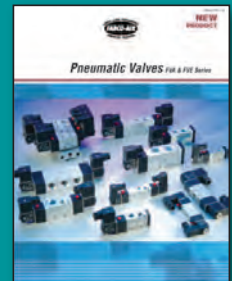

Air Pilot & Solenoid Valves
Catalog # FVA-E-09

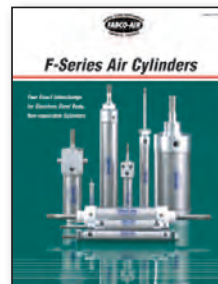

Stainless Steel Body Air Cylinders
Catalog # SSB-03



Pneumatic & Hydraulic Swing Clamps
Catalog # FML-H